



# Silentia PopUp

HOSPITAL IN A BOX



# Silentia PopUp, flexible privacy in any emergency

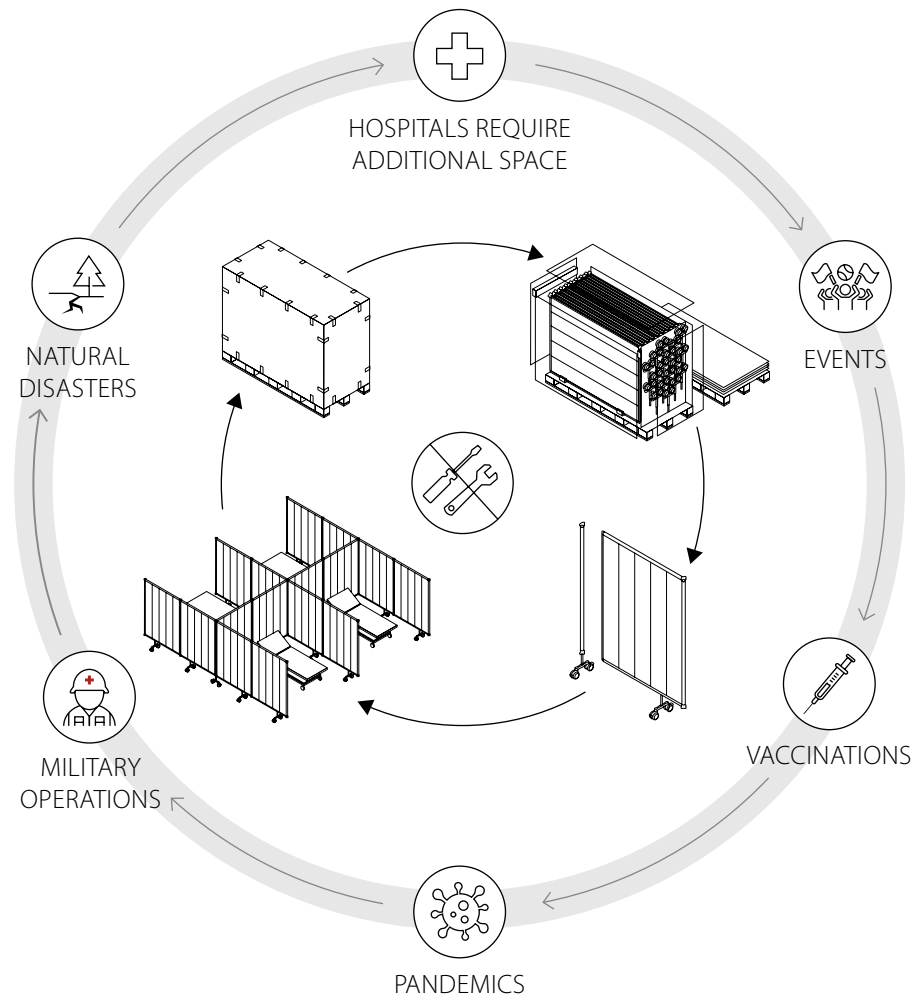

The detachable spring steel clips allow tool-free assembling and disassembling.



EasyClick™ enables tool-free panel attachment. The Silentia holder ensures quick access to equipment.

## Transport

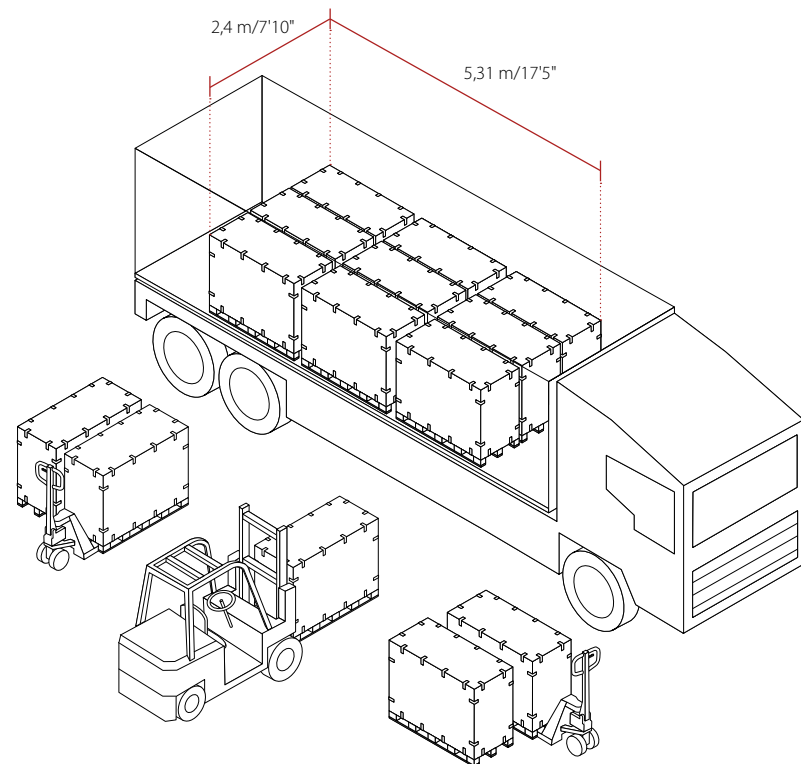

## Storage

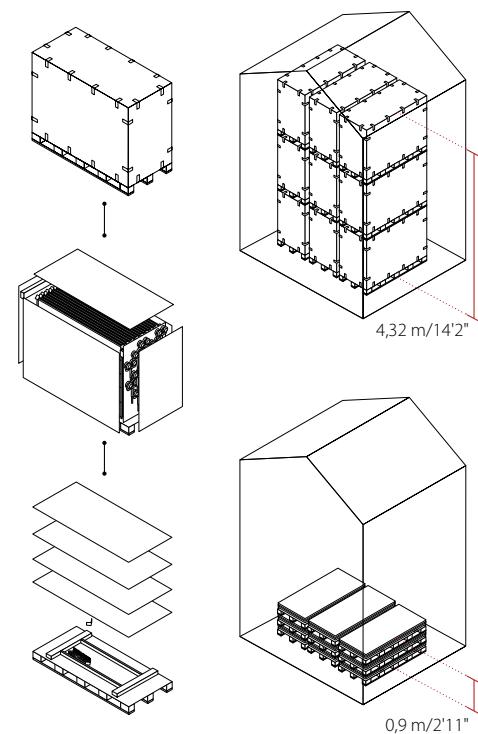

# An emergency box for urgent privacy and flexibility

The Silentia PopUp was designed for temporary, safe patient environments during emergencies or for privacy needs in public spaces like arenas and sport halls.

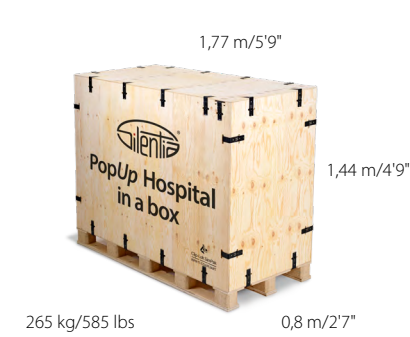

Tool-free assembly and disassembly, ISPM15-compliant plywood box. Delivered on an extended EU pallet.

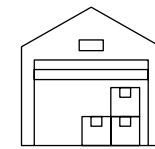

The wooden box is durable for long-term storage and can be stacked.

## Silentia holder

Add Silentia holders to the PopUp.

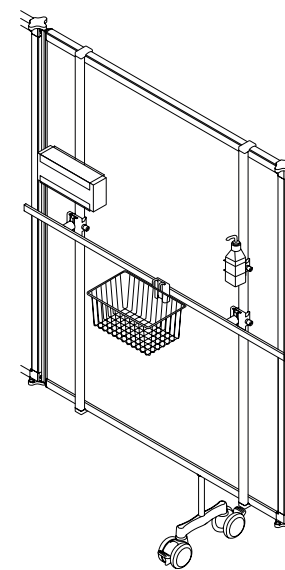

The Silentia holder gives easy access to personal protective gear, medical rail, equipment, etc.



A box contains one start pole and 16 panel walls. The panels are opaque frosted letting light shine through.

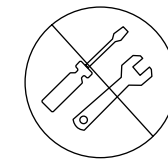

No tools or additional accessories are required for either the box or panels.

Holder:



Accessory clamp:

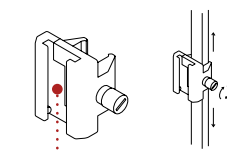

Inner measurements:  
Depth: 0,5 mm/0.19"  
Width: 30 mm/1.18"

Adapter plate:

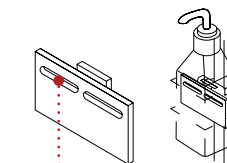

Attachment holes  
(Mounting bolts included)

Accessory clamps and adapter plates allow an easy addition of equipment and accessories.

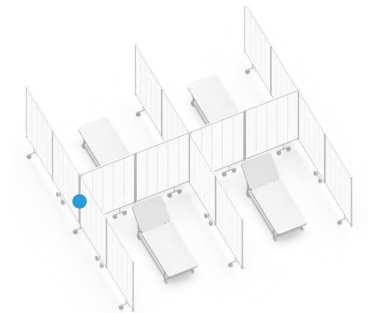

One box contains for example four patient rooms, or 8 vaccination booths. Units are all mobile.



Panels are easy to clean on-site and withstand healthcare disinfectants.

1.

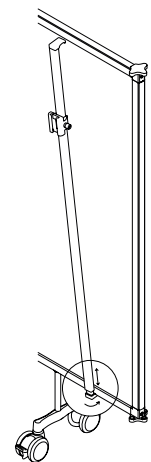
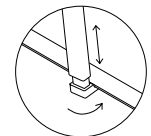

2.

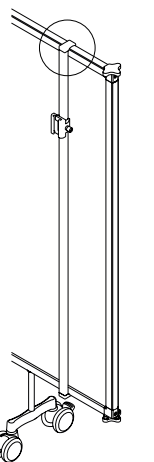
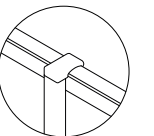

The Silentia holder attaches to the Silentia screen and does not require any tools.

## Patient rooms

The Silentia PopUp offers a fast, flexible solution for setting up temporary medical units.

x1 15 min x1  
= 4 rooms

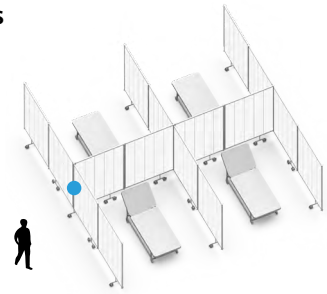

x1 30 min x2  
= 8 rooms

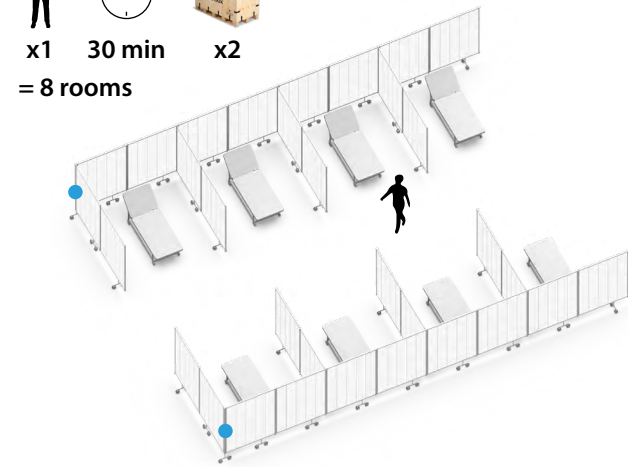

● Start pole

## Vaccination booths

The Silentia PopUp can easily be reconfigured into vaccination booths, offering both one- or two-sided solutions.

x1 15 min x1  
= 8 booths

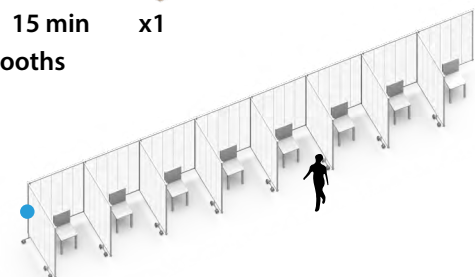

x1 30 min x2  
= 20 booths

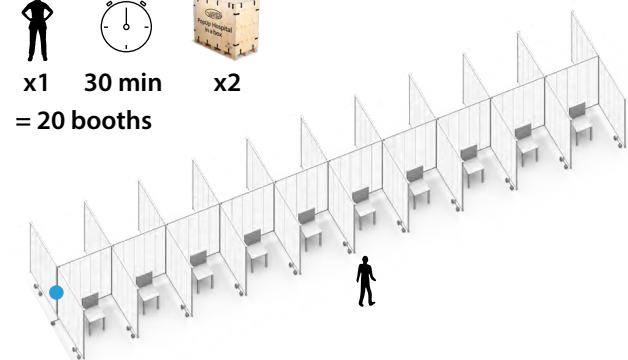

## Modular rooms

Divide a large room or an enclosed space into smaller modular rooms, for use by emergency/pandemic response teams, international assistance organizations, military field hospitals, etc.

x1 90min x6  
= 2 admin rooms  
= 17 patient rooms

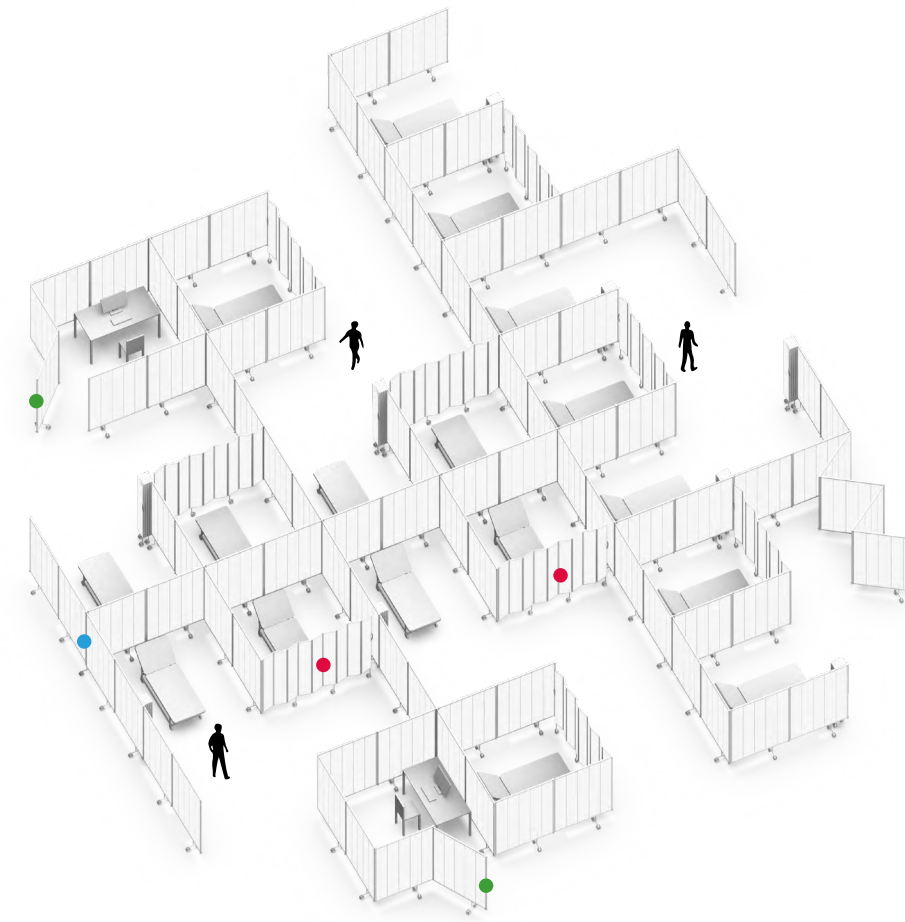

● Start pole

● Door

Panel walls can be used as doors.

● Folding wall

Combine panels and create larger folding walls.

### Additional



● Folding screen

Add Silentia folding screens for full patient privacy with EasyClick™.



# A proven track record

Silentia is a Swedish company founded in 1989. Today we are a global and innovative company with extensive experience of hygienic patient privacy solutions in health care settings. Dedicated local and regional Silentia reps mean your team has ongoing expertise to support you.



Silentia Inc.  
+1 (267) 457-4477  
info@silentia.us  
www.silentia.com